

QUICK PLUG CONNECTOR P.C.B.-TQS-D-2.8-XXP-X

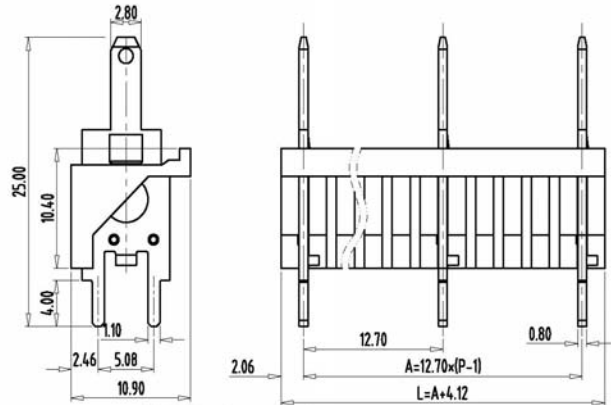

PCB Layout

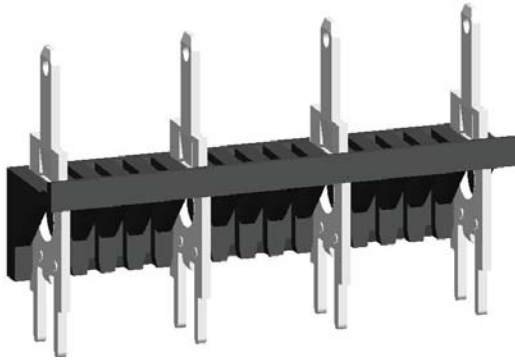
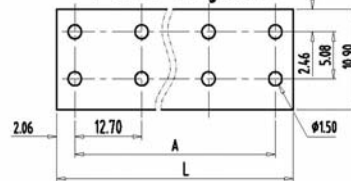

■ 图示(Pic. shown) : TQS-D-2.8-04P-K

General.	Quick plug connector P.C.B Rated : 300V,6A
	Single row , 12.70mm pitch , 02-07 Pole
	Orientation: 90°(plug-in to board)
	Screw clamp unit:

认证 (Approval) :

■ 技术参数 Technical Data	UL standard			IEC standard		
	UL应用组别(UL Application group)	UL Application group			IEC过电压别/污染等级(IEC overvoltage category /pollution degree)	
IEC过电压别/污染等级(IEC overvoltage category /pollution degree)	B	C	D	III / 3	III / 2	II / 2
额定电压(Rated voltage)	300V	300V	--	--	--	--
额定电流(Rated current)	6A	6A	--	--	--	--
额定连接容量(Rated connection capacity)	--			--		
绝缘材料(Insulation Material)	PC UL 94 V0					
电流承载部件材料和镀层(Material & Plating of Current carrier)	Steel , Tin plated					
接线弹片材料(Material of Clamp spring)	--					
绝缘电阻(Insulation Resistance)	500MΩ or more at DC500V					
耐电压(1分钟)(Withstanding Voltage/1Min)	1600V					
额定冲击电压(Rated surge voltage)						
适合的母端接线范围(Suitable Wire Range in female contact)	18AWG					
固定螺丝(Mounting Screw) , 扭矩(torque)	--					
剥线长度(Wire stripping length)	--					
使用温度(Operating temperature)	-40°C up to +125°C					
焊接方式(Soldering recommend)	Wave soldering ,260°C 5S Max (Single Wave) , 260°C 10S Max(Double Wave)					

■ 订购方式(How to order)

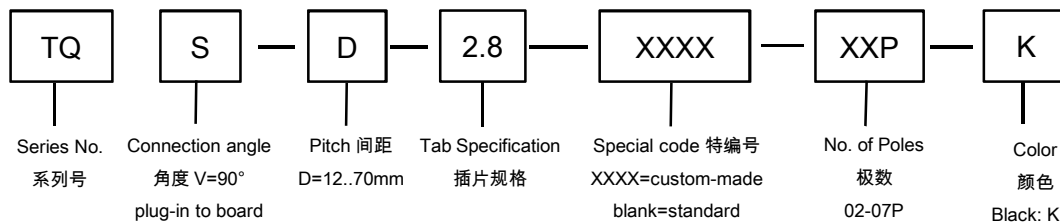

Web:www.china-tianli.com TEL:+86-574-6347-9600,6389-6436 Mail : sale@china-tianli.cn
地址:中国浙江省宁波杭州湾新区庵东工业园区纬三路138号
ADD : 138 , Weisan Rd.,Andong Development Zone, Hangzhou Bay Area, Ningbo, Zhejiang, China