

RAILMOUNTED TERMINAL BLOCKS — END COVER — TB60E-A

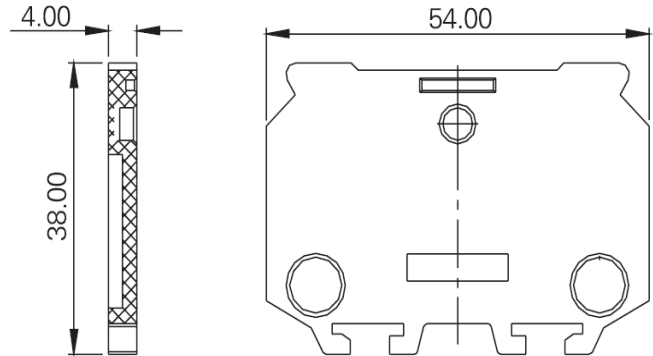

■ 图示(Pic. shown) : TB60E-A-K

General:	End cover
	Insulation Material: PC , V2
	Wiring orientation: /
	Screw clamp unit: /

认证 (Approval) :

技术参数 Technical Data	UL standard			IEC standard		
UL应用组别(UL Application group)	UL Application group			IEC过电压别/污染等级(IEC overvoltage category /pollution degree)		
IEC过电压别/污染等级(IEC overvoltage category /pollution degree)	B	C	D	III / 3	III / 2	II / 2
额定电压(Rated voltage)	--	--	--	--	--	--
额定电流(Rated current)	--	--	--	--	--	--
额定连接容量(Rated connection capacity)	--			--		
绝缘材料(Insulation Material)	PC , V2					
电流承载部件材料和镀层(Material & Plating of Current carrier)	--					
接线弹片材料(Material of Clamp spring)	--					
绝缘电阻(Insulation Resistance)	--					
耐电压(1分钟)(Withstanding Voltage/1Min)	--					
额定冲击电压(Rated surge voltage)	--					
接线螺丝(Wire clamp unit Screw) , 最大扭矩(torque Max.)	--					
固定螺丝(Mounting Screw) , 扭矩(torque)	--					
剥线长度(Wire stripping length)	--					
使用温度(Operating temperature)	-40°C up to +125°C					
焊接方式(Soldering recommend)	--					

■ 订购方式(How to order)

