

PCB Connector — TLP series ( Pin header )— TLPHDL-007V-XXP-HT

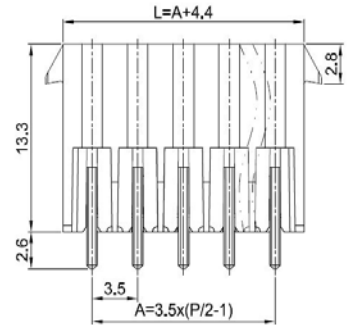
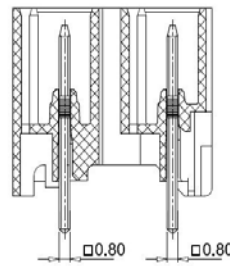
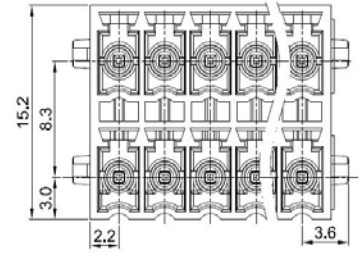
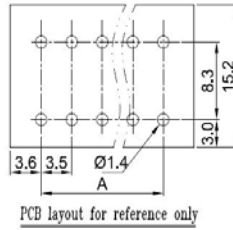

■ 图示(Pic. shown) : TLPHDL-007V-10P-HT-K

General: PCB Connector Rated : 160V,10A  
Single row, 3.50mm pitch , 04-48 Pole  
Orientation: 90°(plug-in to board)

认证 ( Approval ) :

■ 技术参数 Technical Data	UL standard			IEC standard		
	UL Application group			IEC过电压别/污染等级(IEC overvoltage category /pollution degree)		
UL应用组别(UL Application group)	UL Application group			IEC过电压别/污染等级(IEC overvoltage category /pollution degree)		
IEC过电压别/污染等级(IEC overvoltage category /pollution degree)	B	C	D	III / 3	III / 2	II / 2
额定电压(Rated voltage)	300V	--	300V	--	160V	--
额定电流(Rated current)	8A	--	8A	--	10A	--
额定连接容量(Rated connection capacity)	--			--		
绝缘材料(Insulation Material)	--			PA9T/LCP UL94 V-0		
电流承载部件材料和镀层( Material & Plating of Current carrier )	--			Copper alloy , Tin plated		
接线弹片材料(Material of Clamp spring )	--			--		
绝缘电阻(Insulation Resistance)	--			500MΩ or more at DC500V		
耐电压(1分钟)(Withstanding Voltage/1Min)	--			1600V		
额定冲击电压(Rated surge voltage)	--			--		
接线螺丝(Wire clamp unit Screw), 最大扭矩( torque Max. )	--			--		
固定螺母(Mounting Nut), 扭矩(torque)	--			--		
剥线长度(Wire stripping length)	--			--		
使用温度(Operating temperature)	--			-40°C up to +130°C		
焊接方式(Soldering recommend)	Wave soldering & Reflow soldering ( THR ) capable					

■ 订购方式(How to order)

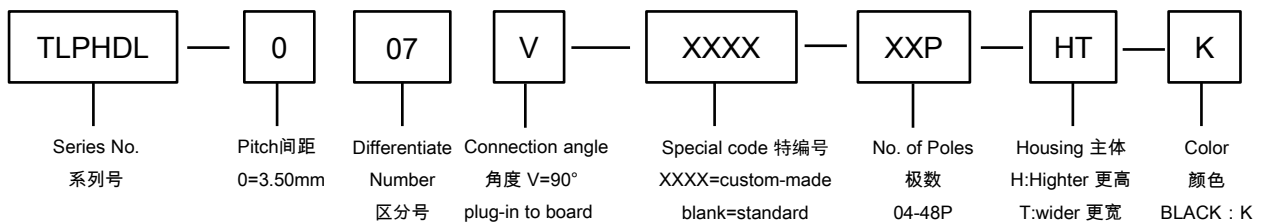

■ 编码片 Coding key



P/N:  
TLPCK-001-S

■ 插头 ( Female Connector )

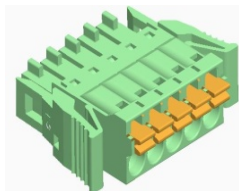

P/N : TLPSL-007  
Wiring orientation :  
180°(wire to plug-in )  
Rated : 160V,10A , 1.5mm<sup>2</sup>  
Spring clamp unit

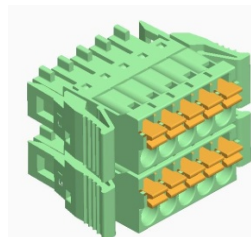

P/N : TLPSDL-007  
Wiring orientation :  
180°(wire to plug-in )  
Rated : 160V,10A , 1.5mm<sup>2</sup>  
Spring clamp unit